

**UH** UNIVERSAL  
HOBBIES

For those who prefer the finest.



\* PROTOTYPE IN RESIN / MASSEY FERGUSON NEXT CONCEPT / ITEM UH6279

## **Edition #01 - 2021**

Die-cast models & plush toys  
Farming & Construction equipment lines



Click to access our website  
➤ [www.universalhobbies.biz](http://www.universalhobbies.biz)

# Edition #01 2021

# CONTENTS

Click to access the category directly ↓

<b>ABOUT US</b>	<b>004</b>
<b>FARMING LINE</b>	<b>006</b>
SCALE 1:16	008
SCALE 1:32	020
SCALE 1:43	126
SCALE 1:87	128
KEYCHAINS	130
<b>CONSTRUCTION EQUIPMENT LINE</b>	<b>136</b>
SCALE 1:12	138
SCALE 1:50	140
KEYCHAINS	154
<b>STUFFED TOYS</b>	<b>156</b>





# ABOUT US



UNIVERSAL HOBBIES is one of the leading brands in the world of farm and construction collectible replicas. For more than 20 years we aim at improving the quality level of our models while offering a large choice in the different scales.

Our collectibles are produced by using die casting method combined with injection molding for plastic and rubber parts. To ensure the finest details, we prefer tampo-printing as opposed to sticker details. This gives our product permanent printings that will not fade or peel in time. The tampo-printing process can take up to 400 presses to complete a single model!

Last but not least, each collectible comes in a specific and official packaging designed in partnership with the manufacturer. We believe all these little details make our products stand out from those of our competitors. Our die-cast models are suitable for **ages 14 and over**.



HAND ASSEMBLED



THERE IS A CHILD INSIDE EACH ONE OF US!

UHKids is glad to introduce at the end of this catalog its growing range of stuffed toys inspired by some of the most successful farm and construction equipment models. All our toys are in-house designed, approved by manufacturers and fully licensed in Europe and North America. These toys feature high quality materials and embroideries. They will make a perfect gift for your little one's **aged 3 and over**.



IN-HOUSE DESIGN

# SYMBOLS & MEANINGS



MODEL'S DIMENSIONS



MODEL'S WEIGHT



NUMBER OF TAMPO-PRINTINGS ON THE MODEL



NUMBER OF PIECES INCLUDING METAL PARTS, PLASTIC AND RUBBER PARTS



FRONT / REAR ADJUSTABLE THIRD POINT LINKAGE →

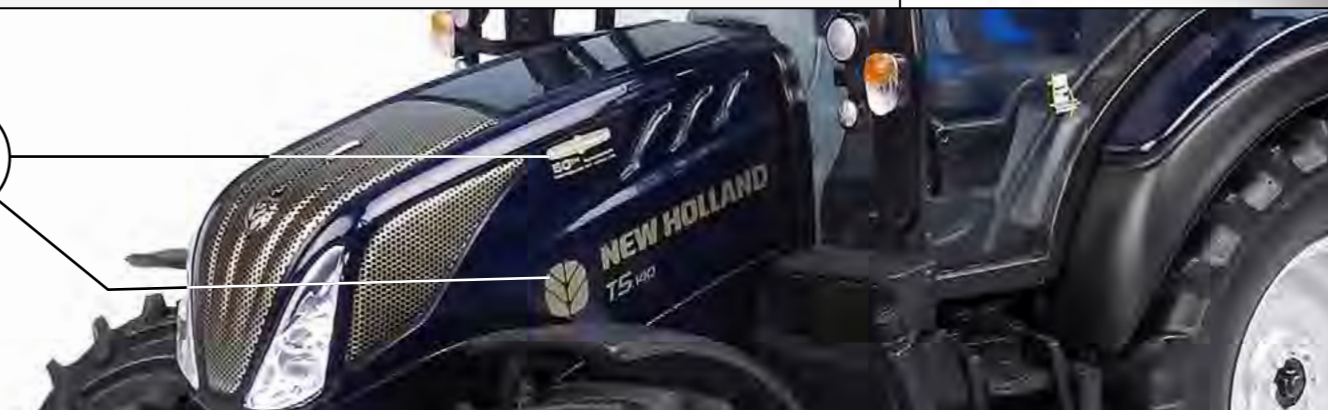

OFFICIAL PACKAGING  
UH6254





 [Back to contents](#)

# FARMING LINE

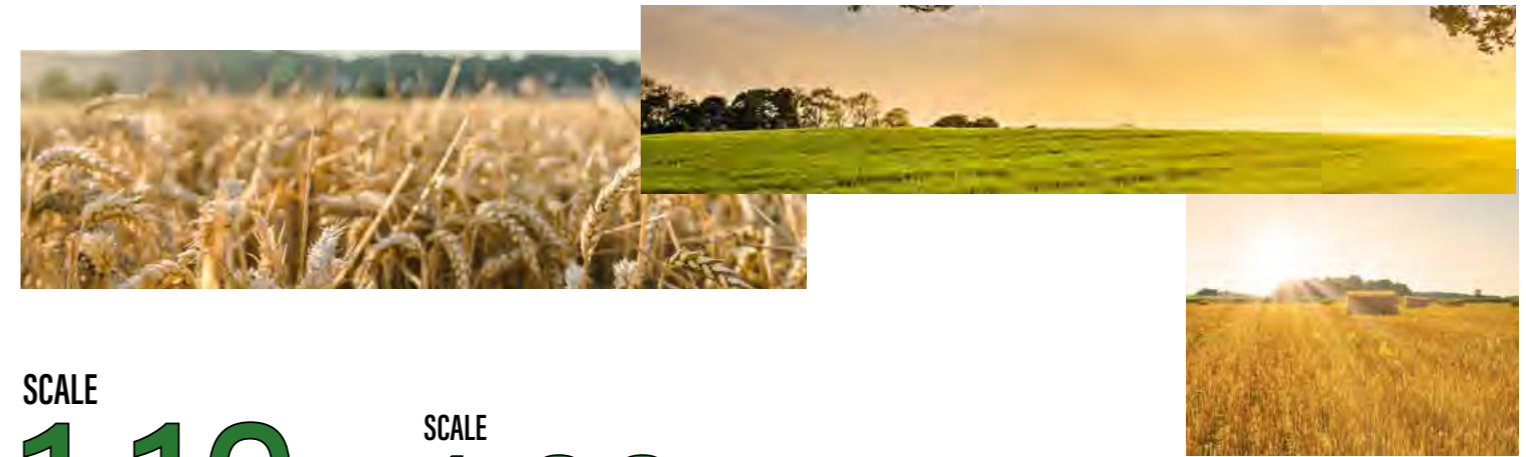
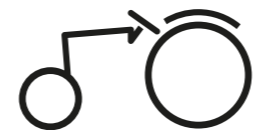

SCALE **1:16** | SCALE **1:32** | SCALE **1:43** | SCALE **1:87** | **Keyrings**





## FARMING LINE





SCALE

# 1:16

Click to access the brand directly ▾

FORDSON	009
FORD	013
FERGUSON	015
MASSEY FERGUSON	019



 145 pcs  
  10 times  
  528 g  
  21.0 x 10.5 x 14.0 cm



FORDSON E27N - 1945  
UH2638





**BACK IN STOCK**



**FORDSON Super Major New Performance**  
UH2780

155 pcs 115 times 576 g 18.5 x 10.3 x 13 cm



**BACK IN STOCK**

**FORDSON Power Major - 1958**  
UH2640



158 pcs 14 times 554 g 21.0 x 11.0 x 13.0 cm







**BACK IN STOCK**

 137 pcs  
  161 times  
  450 g  
  18.2 x 10.0 x 11.6 cm







↗ **FORDSON Super Dexta Diesel 2000 U.S version**  
UH2902



↘ **FORD 5000 - 1964**  
UH2705



 149 pcs  
  30 times  
  627 g  
  23.0 x 10.5 x 11.0 cm







↳ FORD 7000  
UH2798

**BACK IN STOCK** ↗



151 pcs 233 times 946 g 23 x 10.5 x 15 cm



121 pcs 95 times 387 g 170 x 9.0 x 8.0 cm



↳ FERGUSON TEA 20 - 1949  
UH2690

**BACK IN STOCK** ↗







← **FERGUSON TEA 20 with front loader - 1947**  
[UH4171](#)





 199 pcs  
  101 times  
  588 g  
  28.5 x 9.5 x 9.0 cm



#### ABOUT THIS MODEL

- 1/ Working front loader
- 2/ Detachable weight



 124 pcs  
  117 times  
  415 g  
  17.0 x 9.0 x 8.0 cm



↗ **FERGUSON TEA 20 "Half Track"**  
[UH5303](#)

#### ABOUT THIS MODEL

- 1/ Half track system with rubber caterpillar
- 2/ Opening engine hood
- 3/ Working steering wheel







135 pcs 131 times 368 g 18.5 x 9.6 x 8 cm

→ FERGUSON FE 35 - 1956  
UH2986

BACK IN STOCK ↩



↓ MASSEY FERGUSON 135  
UH2698

129 pcs 20 times 476 g 19.6 x 10.8 x 12.7 cm

BACK IN STOCK ↩







# FARMING LINE

SCALE

# 1:32

Click to access the brand directly ↘

AMAZONE	021
BEDNAR	030
CASE IH - DAVID BROWN	031
CHALLENGER	040
DANGREVILLE	041
DEUTZ-FAHR	042
FENDT	045
FORDSON	051
FORD	052
COUNTY	055
JOSKIN	057
KUBOTA	059
KUHN	063
LANDINI	070
LEMKEN	071
MANITOU	073
SALTI	075
FERGUSON	076
MASSEY FERGUSON	078
NEW HOLLAND	092
FIAT	107
STEYR	109
STRAUTMANN	110
TAARUP	112
TRACTORBUMPER	114
URSUS	116
VALTRA	117
VICON	120
VOLMER	120
WEEKS	121
YANMAR	124
ZETOR	124



**AMAZONE**  
SCALE 1:32

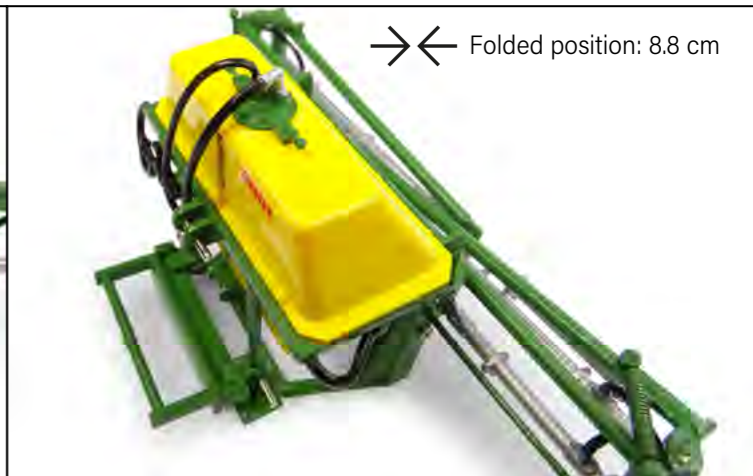
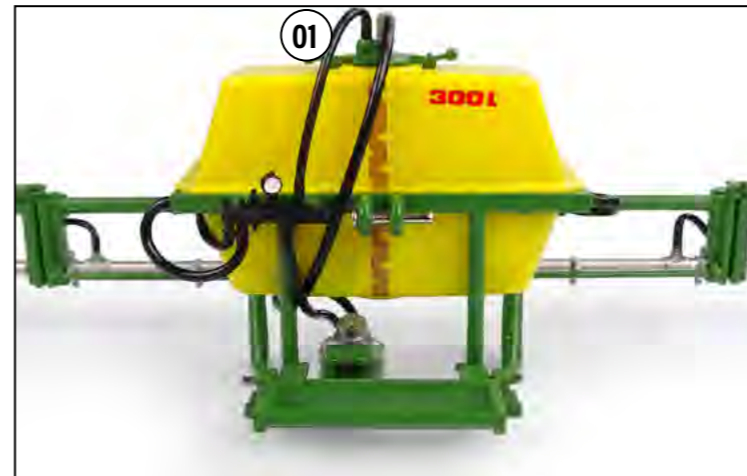

18 pcs   
 27 times   
 12 g   
 3.6 x 8.8 x 4.3 cm

**ABOUT THIS MODEL**  
 1/ Soft PVC hoses  
 2/ Movable arms



**AMAZONE sprayer S300**  
 UH6233 \* TRACTOR NOT INCLUDED







↓ **Set of AMAZONE S300 with FENDT Farmer 2 and farmer figurine**  
 UH6201 EACH BOX IS INDIVIDUALLY NUMBERED



108 pcs 139 times 114 g 14.6 x 8.8 x 8.2 cm



94 pcs 132 times 414 g 22.5 x 8.5 x 9.5 cm



AMAZONE ZG-TS 10001  
 UH5344 \* TRACTOR NOT INCLUDED











← Total length unfolded: 110 cm →

**ABOUT THIS MODEL**

- 1/ New platform and hand rails
- 2/ New rim
- 3/ New fuel cap and new cables

↓ **AMAZONE UX 5201**

UH5397

-  130 pcs
-  177 times
-  315 g
-  12.5 x 22.0 x 9.0 cm

↓ **AMAZONE UX 5201**

UH5397

**ABOUT THIS MODEL**

- 4 /New top boom cover
- 5/ New fenders, supports and warning signs
- 6 /New side cover



\* TRACTOR NOT INCLUDED





178 pcs 235 times 660 g 270 x 9.0 x 13.0 cm

Total length unfolded: 110 cm



AMAZONE Pantera 4503 UH5394

ABOUT THIS MODEL  
1/ Detailed interior cabin  
2/ Four directional working wheels



AMAZONE Pantera 4503 UH5394





BACK IN STOCK



AMAZONE Centaya 3000 Super + T-Pack UH5384 \* TRACTOR NOT INCLUDED



AMAZONE T-PACK IN STOCKING POSITION 1/ Folding supports



THE AMAZONE KG3001 SUPER CAN BE SPLITTED FROM THE CENTAYA HARROW MOUNTED SEED DRILL



ABOUT THIS MODEL 2/ Movable track markers 3/ Folding ladder

AMAZONE Centaya 3000 Super + T-Pack UH5384 \* TRACTOR NOT INCLUDED

183 pcs 191 times 198 g 14.2 x 10.3 x 8.1 cm







➤ **BEDNAR Chisel Plough Terraland TN-Profi**  
UH6217

118 pcs 56 times 193 g 15.7 x 11.7 x 5.5 cm



\* TRACTOR NOT INCLUDED



BACK IN STOCK



➤ **DAVID BROWN 1490 - 4WD**  
UH4279

BACK IN STOCK



➤ **DAVID BROWN 1490 - 2WD**  
UH4270



03

112 pcs 76 times 312 g 14.0 x 7.0 x 8.5 cm



114 pcs 81 times 281 g 14.0 x 7.0 x 8.5 cm

**ABOUT THIS MODEL**

- 1/ Very detailed David Brown 4 cylinders turbo charged diesel engine
  - 2/ Specific rim wheel + wheel hub
  - 3/ Specific David Brown front axle
  - 4/ Third point linkage adjustable.
- New standard realistic coupling system



02

UH4279



04





WITH 4 WHEEL DRIVE FRONT AXLE

↑ CASE 1494 - 2WD  
UH4280

↑ CASE 1494 - 4WD  
UH6208

114 pcs 73 times 282 g 14.0 x 7.0 x 8.5 cm

115 pcs 104 times 315 g 14.0 x 7.0 x 8.5 cm



WITH 4 WHEEL DRIVE FRONT AXLE

↑ CASE International 1494 - 4WD - Red  
UH6210

↑ CASE International 1494 - 2WD - Red  
UH6209

115 pcs 87 times 315 g 14.0 x 7.0 x 8.5 cm

115 pcs 83 times 282 g 14.0 x 7.0 x 8.5 cm





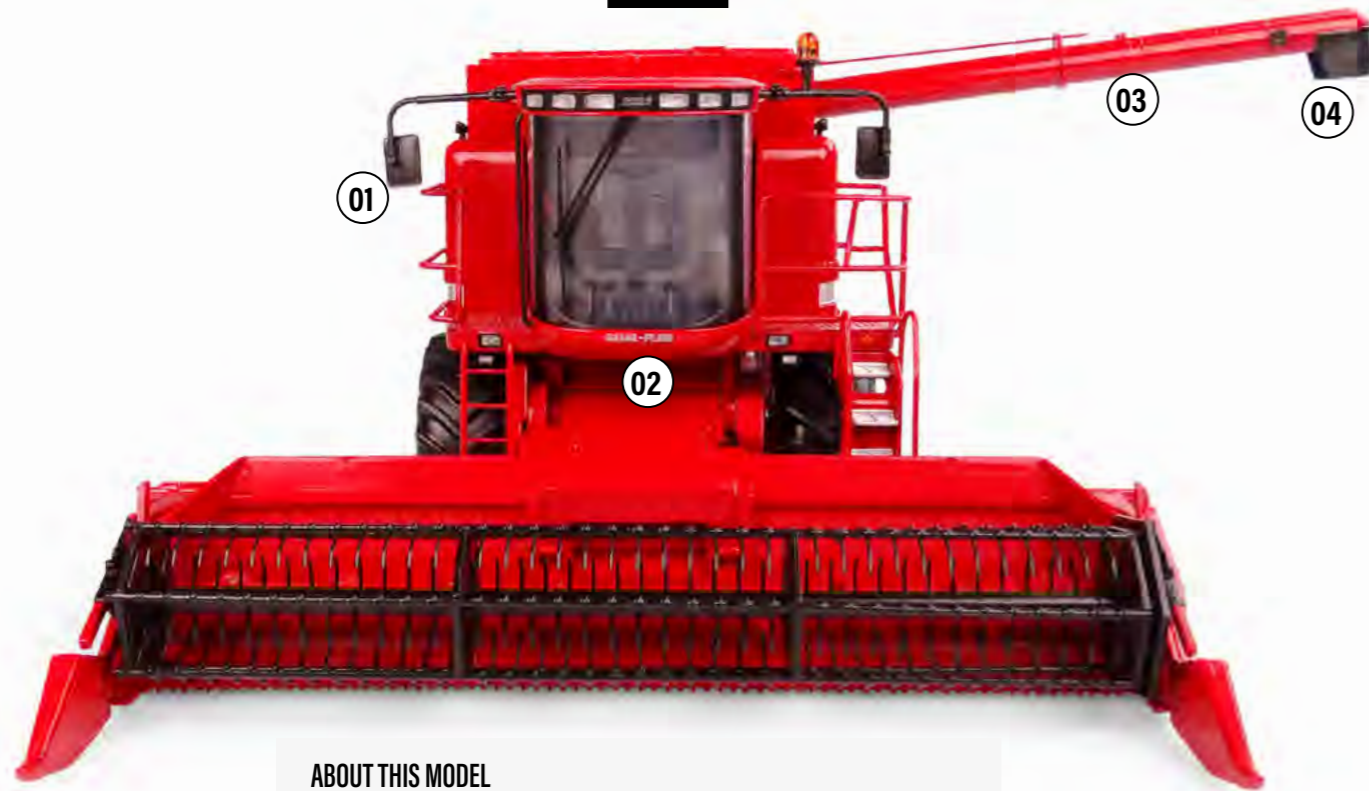





**ABOUT THIS MODEL**

- 1/ Outside mirror support is movable and in metal
- 2/ "Axial Flow" lettering is tampoprinted on a raised surface
- 3/ Support bar is in metal
- 4/ Soft plastic protection



→ **CASE IH Axial Flow 2188**  
UH5269



 120 pcs  
  154 times  
  1049 g  
  32.0 x 21.8 x 13.8 cm



**ABOUT THIS MODEL**

- 5/ All protective grilles are photoetching metal parts
- 6/ Small triangle parts are separated pieces
- 7/ Ladder can rotate
- 8/ Folding ladder
- 9/ Clear part tampoprinted
- 10/ Protective part made with soft plastic

↖ **CASE IH Axial Flow 2188**  
UH5269







↑ CASE IH Puma 175 CVX  
UH5261

112 pcs 88 times 462 g 16.8 x 7.8 x 11.8 cm

BACK IN STOCK



BACK IN STOCK



↖ CASE IH Puma 240 CVX  
UH5286

112 pcs 152 times 534 g 17.5 x 8.2 x 10.2 cm

ABOUT THIS MODEL

- 1/ New outside mirrors
- 2/ New Case IH logo with embossing effect
- 3/ New side hood stripes decoration



↗ CASE IH Puma 240 CVX with tracks  
UH5333

160 pcs 161 times 466 g 17.5 x 8.5 x 10.2 cm



### Case IH Puma 175 CVX - 175th Anniversary Edition

UH5285







112 pcs 92 times 462 g 16.8 x 7.8 x 11.8 cm

**ABOUT THIS MODEL**  
 1/ Special 175th anniversary logo  
 2/ Special metallic red body color

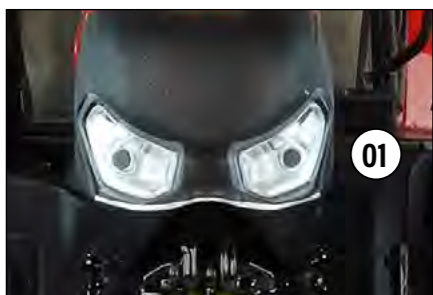

**BACK IN STOCK**



### Case IH Maxxum 145 CVX

UH5266

**BACK IN STOCK**



**ABOUT THIS MODEL**  
 1/ New facelift grille and headlight  
 2/ New lights and turn signal  
 3/ New tank  
 4/ New outside mirrors  
 5/ Additional warning light









115 pcs 86 times 406 g 16.5 x 7.8 x 9.6 cm



### Case IH Vestrum 130 CVX Drive - 2019 version

UH5358

115 pcs 129 times 387 g 16.0 x 7.1 x 9.8 cm

**new**

**Complete new model**





Challenger

CHALLENGER

SCALE 1:32

Back to contents



CHALLENGER MT 685E - Dual wheels  
UH4894

166 pcs 110 times 658 g 19.0 x 12.0 x 10.6 cm

CHALLENGER MT 555E  
UH4875

159 pcs 140 times 588 g 18.0 x 8.0 x 10.0 cm



DANGREVILLE

DANGREVILLE

SCALE 1:32

Back to contents



DANGREVILLE - PE 32  
UH2842

197 pcs 198 times 650 g 41.0 x 8.0 x 10.0 cm







LIMITED EDITION  
1500 PIECES



# D 60 05

↗ DEUTZ D 60 05 4 WD with cabin and front loader  
Includes bucket and fork in gift box  
UH6200

90 pcs 97 times 196 g 170 x 61 x 74 cm

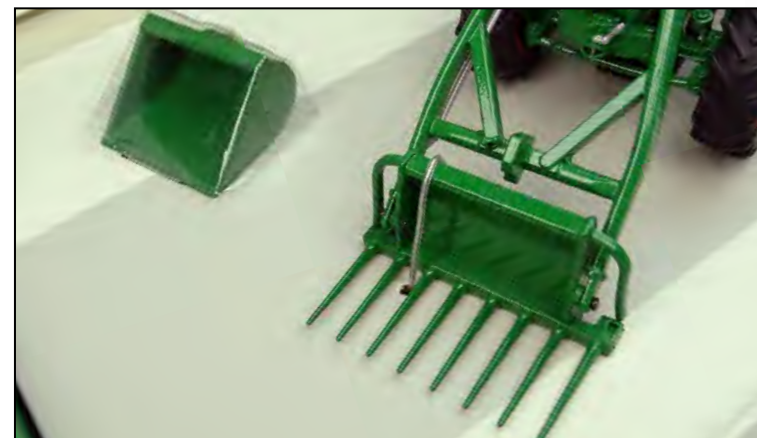

82 pcs 72 times 173 g 11.4 x 6.1 x 7.4 cm

↑ DEUTZ D 60 05 - 4WD with cabin  
UH5253



↗ DEUTZ-FAHR Agrottron 135 MK3  
UH5245





87 pcs 95 times 371 g 15.5 x 7.8 x 10.5 cm





**DEUTZ-FAHR Agrotion TTV 7250 - 6 wheels with farmer figurine**





UH4296

     
174 pcs 152 times 570 g 17.0 x 13.0 x 11.0 cm



**FENDT Farmer 2**



UH4049

     
94 pcs 31 times 96 g 10.2 x 4.9 x 4.9 cm







**FENDT Farmer 3S - 4WD**

UH5308

     
74 pcs 54 times 155 g 11.3 x 5.5 x 5.6 cm

**FENDT Farmer 3S - 2WD**

UH5270

     
73 pcs 52 times 157 g 11.3 x 5.5 x 5.6 cm







SCALE 1:32

[Back to contents](#)

→ **FENDT Farmer 4S - 4WD with roll bar**  
UH5309

79 pcs  
 75 times  
 170 g  
 111.4 x 5.8 x 7.8 cm



**ABOUT THIS MODEL**  
 1/ 2 wheel drive front axle  
 2/ Realistic working rear linkage  
 3/ Complete roll bar

90 pcs  
 85 times  
 166 g  
 12.0 x 5.5 x 8.0 cm

↗ **FENDT Farmer 5S with Peko cabin - 2WD**  
UH5291

SCALE 1:32

[Back to contents](#)



**ABOUT THIS MODEL**  
 1/ Realistic soft canvas side panel  
 2/ Specific 3 angle Peko windshield shape  
 3/ Lower side windshield  
 4/ Soft canvas panel for lower protection  
 5/ Specific BAAS front loader with bucket  
 6/ 4 wheel drive front axle

↘ **FENDT Farmer 5S with Peko cabin and BAAS front loader - 4WD**  
UH5310

96 pcs  
 92 times  
 220 g  
 17.0 x 5.5 x 8.0 cm





**ABOUT THIS MODEL**

- 1/ Specific "Edscha" cabin
- 2/ Specific Fendt frontloader Gr.3
- 3/ 4 wheel drive front axle
- 4/ Realistic working rear linkage



↑ **FENDT Farmer 108LS with "Edscha" cabin and front loader - 4WD**

UH5251

92 pcs   96 times   260 g   170 x 5.5 x 8.0 cm



**ABOUT THIS MODEL**

- 1/ 4X 80 CargoProfi front loader
- 2/ "Nature Green" color



166 pcs   256 times   520 g   21.0 x 8.0 x 11.0 cm

↗ **Fendt 516 Vario with front loader - "Nature Green" color**

UH4981



↗ **FENDT 724 Vario - "Nature Green" color**

UH5231

133 pcs   182 times   500 g   15.0 x 8.5 x 11.0 cm





### ↘ FENDT 722 Vario with front loader - "Nature Green" color

UH4975







  
 167 pcs    271 times    600 g    22 x 8.3 x 11.3 cm







BACK IN STOCK ↗



### → FORDSON Power Major - 1958

UH2636





  
 103 pcs    20 times    105 g    10.5 x 5.5 x 5.2 cm



BACK IN STOCK ↗

### ↘ FORDSON Super Major «New Performance»

UH4880





  
 113 pcs    157 times    105 g    10.5 x 5.5 x 5.2 cm







FORD

SCALE 1:32

Back to contents



LIMITED EDITION  
1 500 PIECES

← FORD 5000 with metal wheels  
UH4879



94 pcs

165 times

135 g

11.5 x 8.5 x 7.0 cm



↖ FORD 5000 - 1964  
UH2808

BACK IN STOCK ↗



92 pcs

32 times

111 g

11.5 x 5.5 x 7.0 cm

SCALE 1:32

Back to contents



→ FORD 6610 - 4WD - Generation I  
UH5367



96 pcs

130 times

281 g

13.3 x 7.3 x 8.8 cm

BACK IN STOCK ↗



↑ FORD 7810  
UH2865

BACK IN STOCK ↗



105 pcs

154 times





283 g

14.0 x 7.2 x 8.5 cm



### ↳ FORD 7810 «Jubilee Edition»

UH2882





 109 pcs  
  157 times  
  283 g  
  14 x 7.2 x 8.5 cm

**BACK IN STOCK** ↗



### ↳ FORD TW-35 4WD - 1983

UH4027

 112 pcs  
  150 times  
  355 g  
  14.5 x 7.5 x 9.0 cm

**BACK IN STOCK** ↗







**BACK IN STOCK** ↗



### ↗ FORD COUNTY 1474

UH4032

 110 pcs  
  161 times  
  435 g  
  16.0 x 8.0 x 9.0 cm





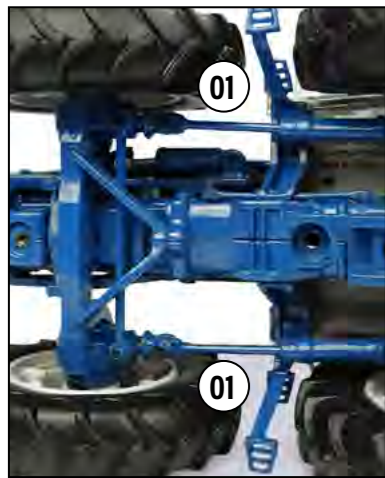

**FORD COUNTY 1174**  
UH5271

104 pcs 78 times 291 g 12.5 x 6.8 x 9.5 cm

**BACK IN STOCK**

**ABOUT THIS MODEL**

- 1/ Wheels of equal size with double transmission specific to the County 1174 4 wheel-drive
- 2/ Detailed engraved front grille
- 3/ Realistic working rear linkage
- 4/ Wheel weights specific to the County 1174



**JOSKIN WAGO TR 10000 T20**  
UH5225

145 pcs 80 times 1008 g 38.0 x 8.5 x 12.0 cm



**JOSKIN Betimax RDS 7500**  
UH2580

107 pcs 156 times 296 g 29.5 x 8.0 x 8.4 cm



**ABOUT THIS MODEL**

- 1/ Realistic double rim connecting link
- 2/ New 10 screws rim instead of 8
- 3/ New armrest design
- 4/ New outside mirrors and supports
- 5/ Complete new exhaust pipe design
- 6/ New model number printing
- 7/ New rear «50km» decal
- 8/ New headlight cover color
- 9/ New lights design
- 10/ New warning lights
- 11/ New inner door handrail shape
- 12/ Update lower stair design

**ABOUT THIS MODEL**

- 1/ Opening side door with fold away ladder
- 2/ Retractable bumper
- 3/ Moving shredding beaters
- 4/ Working rear door
- 5/ Very detailed chassis and free steering working wheels
- 6/ Grille made from very thin photoetching
- 7/ Detailed engraving of the yam chain on the floor
- 8/ Tilting front door
- 9/ Folding stand

### ↖ JOSKIN Silo Space 2 silage trailer UH5336

 111 pcs  
  164 times  
  1100 g  
  370 x 7.5 x 12.3 cm

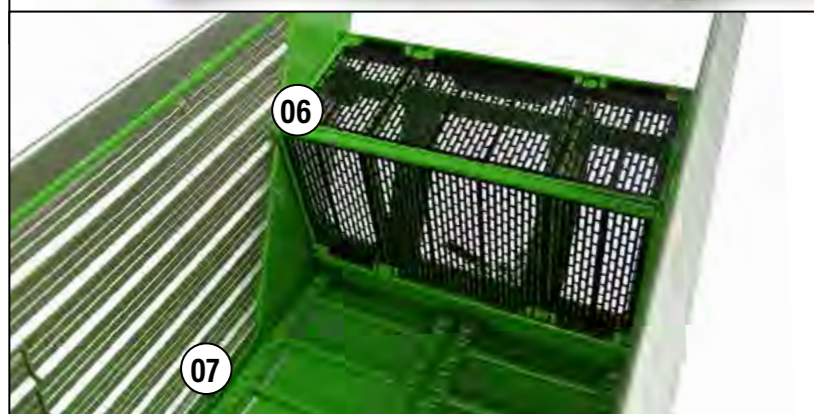

### ↑ KUBOTA M7172 - 2019 - 6 wheels UH5387

 122 pcs  
  119 times  
  492 g  
  16.5 x 12.5 x 8.8 cm







KUBOTA'S FIRST TRACTOR PRODUCED IN JAPAN IN 1960



→ KUBOTA T15 - 1960  
UH4898

117 pcs 93 times 69 g 8.6 x 5.7 x 4.6 cm



→ KUBOTA M108S  
UH4899

83 pcs 62 times 300 g 14.5 x 8.4 x 6.5







↓ **KUBOTA RM2005V**  
UH4930 \* TRACTOR NOT INCLUDED



126 pcs   110 times   64 g   17.5 x 5.5 x 5.0 cm



**BACK IN STOCK**

↓ **KUHN Vari-Master 183**  
UH5355 \* TRACTOR NOT INCLUDED

167 pcs   169 times   88 g   22.5 x 5.5 x 7.5 cm



**ABOUT THIS MODEL**  
1/ New Kuhn and Vari-Master logos







New

↓ **KUHN Prolander 500R**  
UH6267 \* TRACTOR NOT INCLUDED

← 14.4 cm →

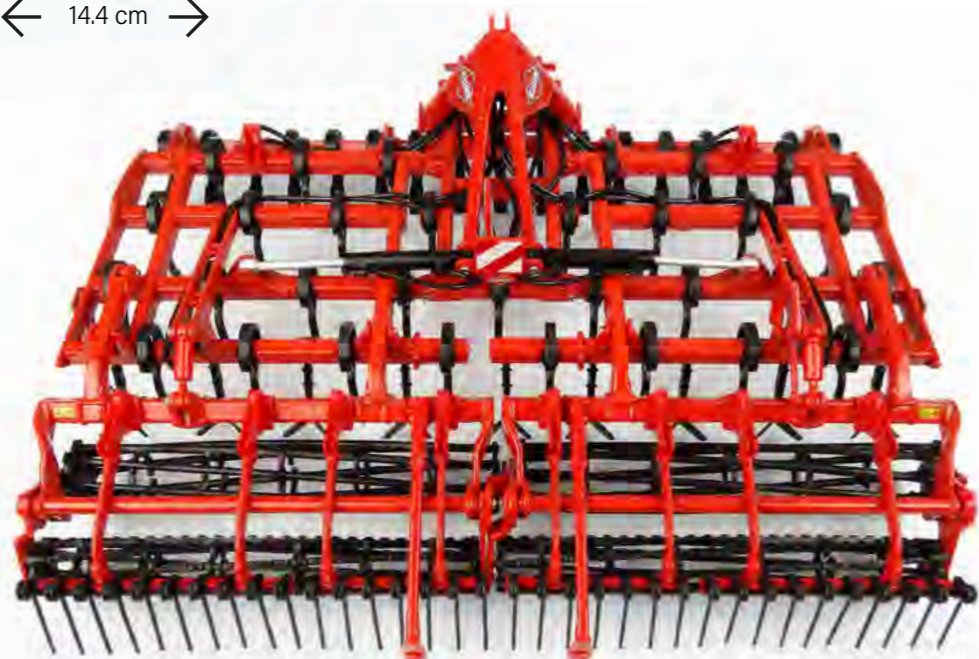

← 16.8 cm →

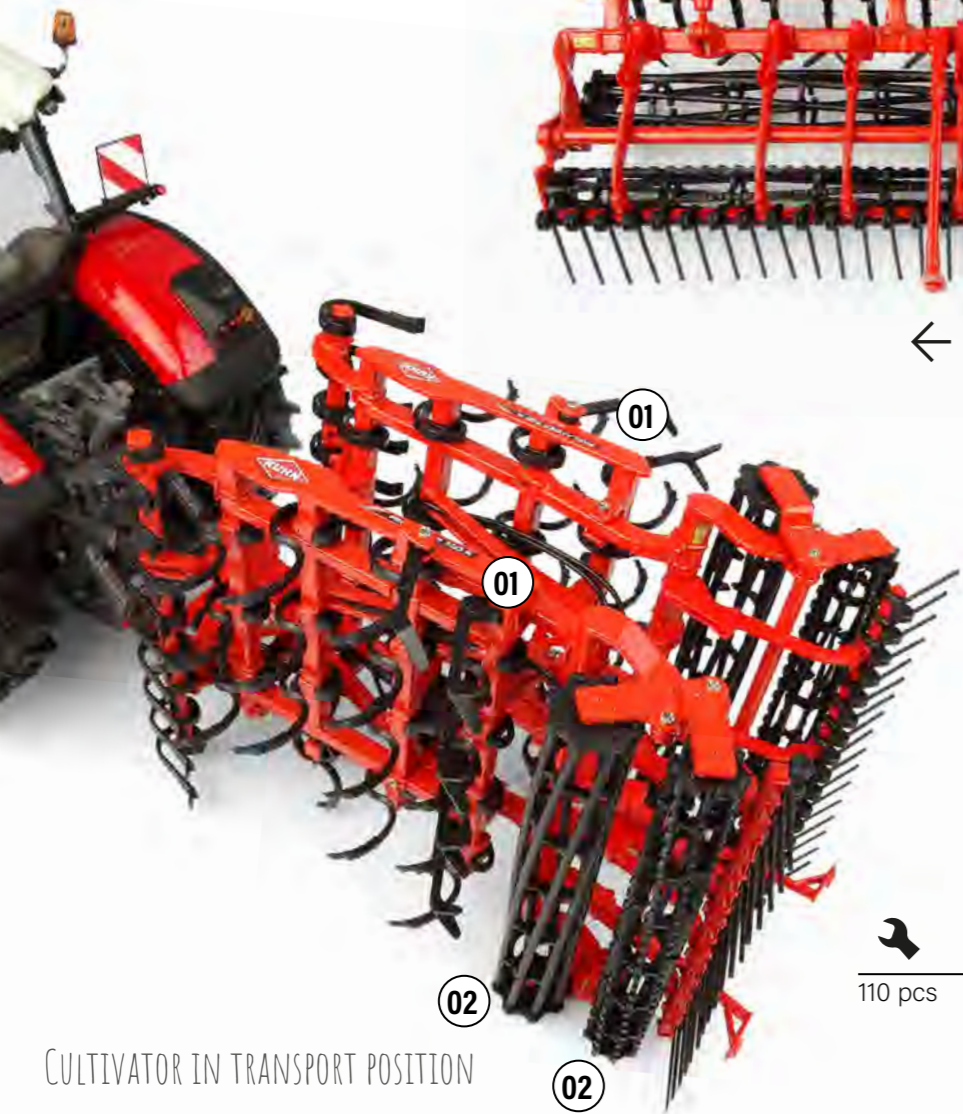

ABOUT THIS MODEL  
1/ Folding parts  
2/ Working rollers

87 pcs 97 times 68 g 8.0 x 11.0 x 4.0 cm

CULTIVATOR IN TRANSPORT POSITION



BACK IN STOCK

↗ **KUHN EL 162**  
UH4199 \* TRACTOR NOT INCLUDED

87 pcs 97 times 68 g 8.0 x 11.0 x 4.0 cm

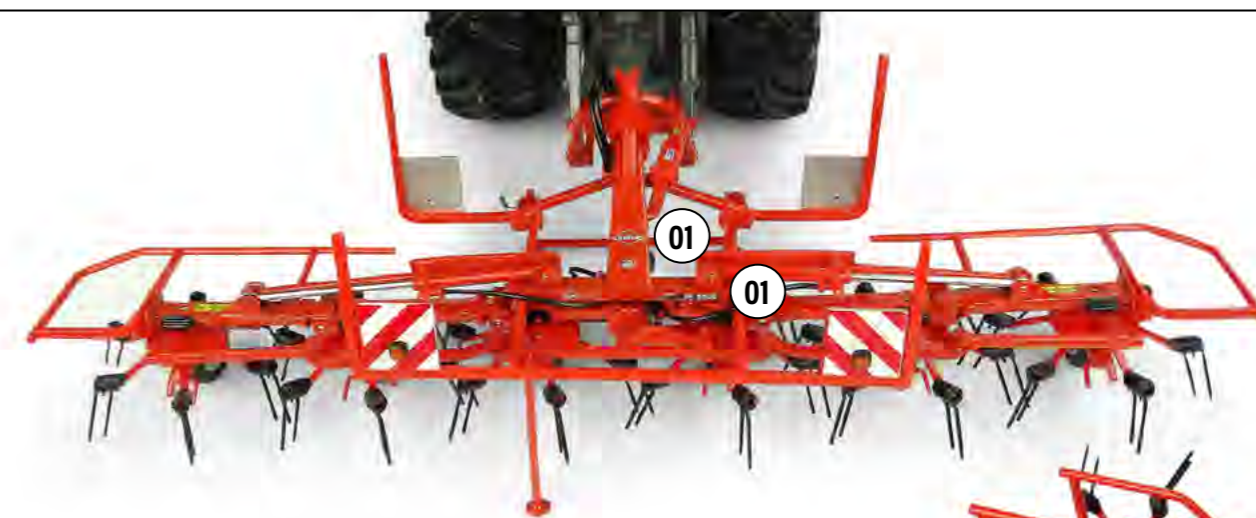

ABOUT THIS MODEL  
1/ New Kuhn and GF-6502 logos

BACK IN STOCK

↗ **KUHN GF 6502**  
UH5356 \* TRACTOR NOT INCLUDED

113 pcs 75 times 63 g 22.5 x 6.5 x 9.0 cm







THE KUHN HR 3040 CAN BE ATTACHED TO THE KUHN VENTA 3030 (UH5221)



← **KUHN HR 3040**  
UH5219 \* TRACTOR NOT INCLUDED

**BACK IN STOCK**

73 pcs 95 times 68 g 21.5 x 7.3 x 4.4 cm



← **KUHN CD 3020**  
UH5218 \* TRACTOR NOT INCLUDED

80 pcs 69 times 64 g 9.5 x 7.3 x 4.4 cm



THE KUHN CD 3020 CAN BE ATTACHED TO THE KUHN VENTA 3030 (UH5221)



157 pcs 111 times 92 g 12.5 x 11.0 x 7.5 cm

→ **KUHN Venta 3030**  
UH5221

THE KUHN VENTA 3030 CAN BE ATTACHED TO THE KUHN CD 3020 (UH5218) TO THE KUHN HR 3040 (UH5219)



\* ITEMS UH5221 + UH5218  
TRACTOR NOT INCLUDED









KUHN TT 3500



∨ **KUHN TT 3500**  
UH4128

     
397 pcs   205 times   312 g   32.0 x 38.0 x 8.0 cm

**ABOUT THIS MODEL**  
1/ Movable parts







99 pcs  
 155 times  
 259 g  
 13.0 x 8.6 x 7.0 cm

→ **LANDINI 4.105**  
UH4944



↓ **LEMKEN Gemini 7 - Front tank**

UH5258 \* TRACTOR NOT INCLUDED

**ABOUT THIS MODEL**

1/ Soft PVC hose to connect to UH2775 "Lemken Mounted Field Rear Sprayer Sirius 9"

2/ Removable coupling trolley to be used for transport and handling of the front tank



40 pcs  
 54 times  
 41 g  
 6.0 x 9.4 x 4.7 cm



01







↓ **LEMKEN Opal 090 - version 1**  
UH5262 \* TRACTOR NOT INCLUDED

REVERSIBLE PLOUGH

40 pcs 50 times 25 g 11.9 x 6 x 4.7 cm



REVERSIBLE PLOUGH

↗ **LEMKEN Opal 090 - version 2**  
UH5279 \* TRACTOR NOT INCLUDED

46 pcs 62 times 26 g 11.9 x 6.0 x 4.7 cm

**ABOUT THIS MODEL**  
1/ New plain DurraMax body plough mouldboard

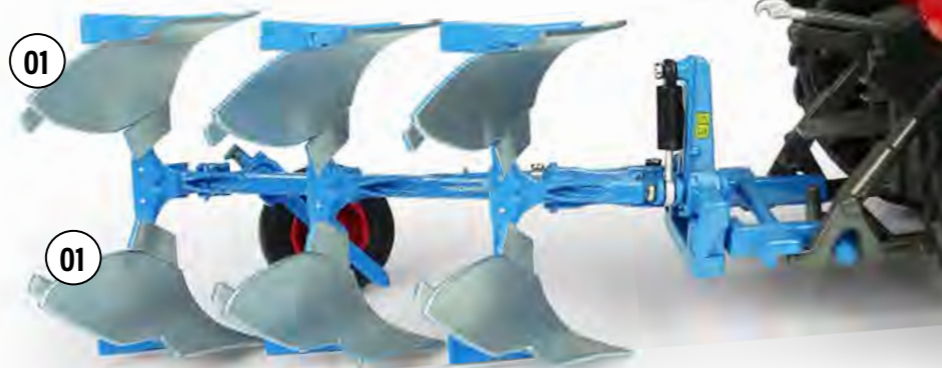

← **MANITOU MI 25D**  
UH2949

70 pcs 58 times 83 g 11.5 x 3.5 x 12 cm





### MANITOU MLT 625-75 H UH2925

163 pcs 83 times 100 g 23.6 x 5.6 x 6.2 cm



**BACK IN STOCK**

### MANITOU MT 625 T Confort with fork UH2924

151 pcs 83 times 185 g 16.0 x 5.5 x 7.8 cm



### MANITOU MT 625 in "Salti" livery UH5398

151 pcs 91 times 185 g 16.0 x 5.5 x 7.8 cm







**FERGUSON**  
SCALE 1:32

[Back to contents](#)



**new**

↑ **FERGUSON implements set - includes four different accessories**  
UH6247

\* TRACTOR NOT INCLUDED

**INSIDE THE BOX**  
1/ Tiller  
2/ 2 row potato planter  
3/ Transport box with milk churns  
4/ 2 furrow plough



SCALE 1:32

[Back to contents](#)



→ **FERGUSON TEA 20**  
UH4189

101 pcs 59 times 56 g 9.0 x 5.0 x 5.0 cm

**BACK IN STOCK**

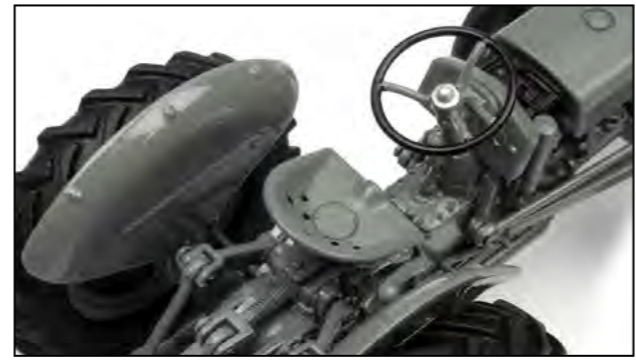

↗ **FERGUSON TO 35 - 1957**  
UH4991

74 pcs 85 times 65 g 8.5 x 5.1 x 6.0 cm







MASSEY FERGUSON

SCALE 1:32

Back to contents



**MASSEY FERGUSON MF21 - 3.5 Ton Hydraulic tipping trailer**

UH6241

\* TRACTOR NOT INCLUDED



New

20 pcs 35 times 126 g 12.9 x 6.0 x 5.7 cm



Back to contents

21 pcs 35 times 132 g 12.9 x 6.0 x 5.7 cm

SCALE 1:32

Back to contents

\* TRACTOR NOT INCLUDED

New



**MASSEY FERGUSON MF21 with grain sides - 3.5 Ton Hydraulic tipping trailer**

UH6242

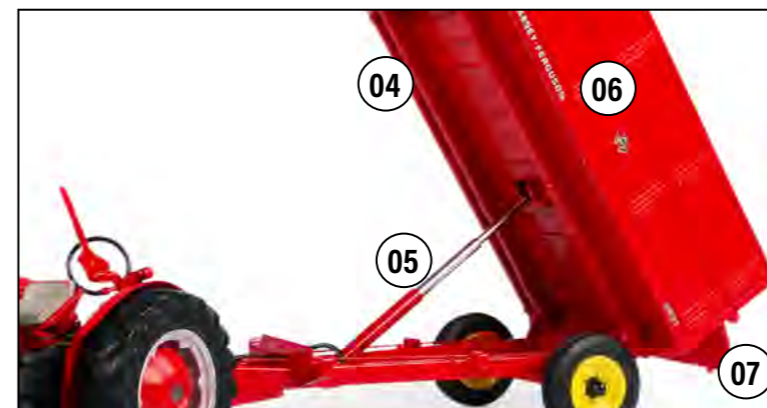

**ABOUT UH6241 - UH6242 - UH6243**

- 1/ Metal chassis
- 2/ Complete new brake, part stand and lever
- 3/ New screw-jack stand
- 4/ New metal frame
- 5/ Working hydraulic cylinder
- 6/ Tampoprinted Massey Ferguson logos
- 7/ Movable rear door

**MASSEY FERGUSON MF21 with silage extension sides - 3.5 Ton Hydraulic tipping trailer**

UH6243

\* TRACTOR NOT INCLUDED

New



**ABOUT UH6243**

- 8/ Rear grilles are in photo etching
- 9/ Rear folding door
- 10/ Silage extension side panels

24 pcs 39 times 145 g 12.9 x 6.0 x 9.7 cm







SCALE 1:32

[Back to contents](#)



**BACK IN STOCK**

↗ **MASSEY FERGUSON n°3 - baler**  
UH5239





 54 pcs  
  47 times  
  108 g  
  19.2 x 11.3 x 8.3 cm

SCALE 1:32

[Back to contents](#)

↓ **MASSEY FERGUSON 35 - 1959**  
UH4989







 78 pcs  
  86 times  
  65 g  
  8.5 x 5.1 x 6.0 cm

↓ **MASSEY FERGUSON 35X**  
UH2701





**BACK IN STOCK**

 90 pcs  
  24 times  
  73 g  
  9.5 x 5.2 x 4.2 cm

↗ **MASSEY HARRIS FERGUSON 202 WORK-BULL**  
UH4990



 74 pcs  
  76 times  
  65 g  
  9.0 x 5.0 x 4.0 cm





**BACK IN STOCK**

← **MASSEY FERGUSON 135 - 1965**  
UH2785

85 pcs   100 times   73 g   10 x 5.4 x 4.7 cm



**BACK IN STOCK**

119 pcs   91 times   420 g   16.5 x 8.0 x 10.5 cm

↗ **MASSEY FERGUSON 8250 Xtra**  
UH6257

**ABOUT THIS MODEL**  
1/ New side hood printing  
2/ Realistic UH coupling system with adjustable third point linkage



↗ **MASSEY FERGUSON 8220 Xtra**  
UH5331

115 pcs   95 times   420 g   16.5 x 8.0 x 10.5 cm

**ABOUT THIS MODEL**  
1/ New standard realistic UH coupling system with adjustable third point linkage





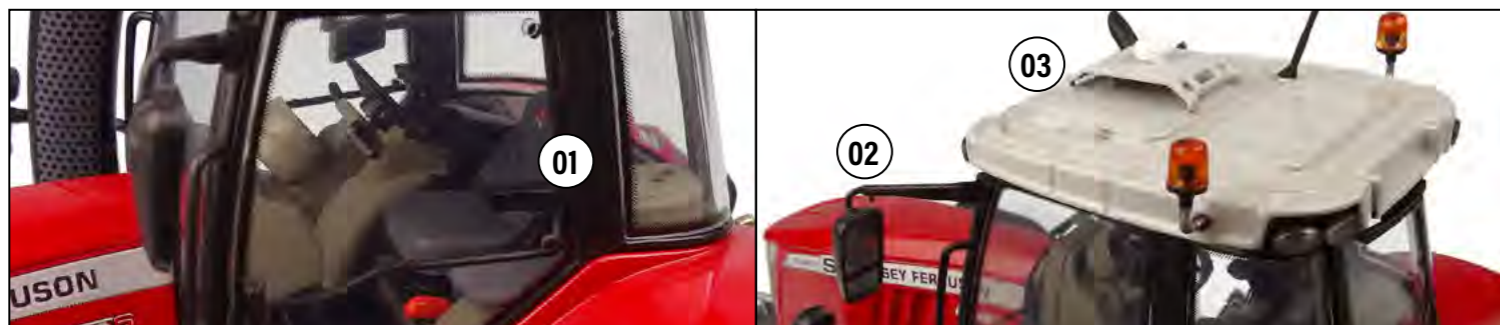

ABOUT THIS MODEL

- 1/ New armrest and seat color
- 2/ New outside mirror design
- 3/ New GPS and support frame
- 4/ New rear wheel weight color
- 5/ New decal and numbering on engine bonnet
- 6/ New front bonnet design



127 pcs 140 times 619 g 18.3 x 11.3 x 8.3 cm

MASSEY FERGUSON 7726 S UH5304

BACK IN STOCK



143 pcs 134 times 669 g 19.0 x 11.5 x 9.0 cm

MASSEY FERGUSON 8740 S - 2019 version UH6216

ABOUT THIS MODEL

- 1/ New exhaust pipe
- 2/ New additional lights, turn signal and supports
- 3/ New fuel tank and new stairs
- 4/ New rear rim with extra weight colored







↓ **MASSEY FERGUSON 5713 S - NEXT Edition**  
UH6258

**ABOUT THIS MODEL**

- 1/ Special black body color
- 2/ Special "Next Edition" logo
- 3/ Special "Next Edition" plate with "built number"



115 pcs   121 times   359 g   15.8 x 9.5 x 8.0 cm



↑ **MASSEY FERGUSON 7726 S - NEXT Edition**  
UH6259

**ABOUT THIS MODEL**

- 1/ Special black body color
- 2/ Special "Next Edition" logo
- 3/ Special "Next Edition" plate with "built number"



121 pcs   147 times   619 g   18.3 x 11.3 x 8.3 cm



# NEXT

Concept tractor



67 pcs 88 times 585 g 170 x 11.5 x 9.0 cm

**New** Complete new model

↓ **MASSEY FERGUSON NEXT Concept Tractor**  
UH6279





# THE NEW MF 8S.265



SCALE 1:32

[Back to contents](#)



02

**new**

Complete  
new model

↓ **MASSEY FERGUSON 8S.265**  
UH6262

#### ABOUT THIS MODEL

- 1/ Foldable mirrors
- 2/ Front and rear standard realistic UH coupling system
- 3/ Adjustable third point linkage



03



105 pcs



123 times



585 g



170 x 11.5 x 9.0 cm





NEW HOLLAND

SCALE 1:32

Back to contents



NEW HOLLAND T5.120 WITH 740TL LOADER

SCALE 1:32

Back to contents



→ NEW HOLLAND T5.120 with 740TL loader UH4958

127 pcs	156 times	421 g	19.4 x 9.7 x 8.4 cm











Complete  
new model



→ **NEW HOLLAND T5.130 - 2019**  
UH5360

**ABOUT THIS MODEL**

- 1/ Adjustable third point linkage
- 2/ New standard realistic UH coupling system



  
 115 pcs    111 times    387 g    16.0 x 9.6 x 71 cm

↘ **NEW HOLLAND T5.130 - low roof - High visibility**  
UH6222





Complete  
new model



**ABOUT THIS MODEL**

- 1/ Complete new low roof with high visibility sunroof
- 2/ Foldable outside mirrors
- 3/ Front and rear adjustable third point linkage
- 4/ Detailed interior with new armrest, screen and gears
- 5/ All wordings are made in tampoprinting









  
 115 pcs    108 times    366 g    16.0 x 9.8 x 71 cm



↘ **NEW HOLLAND T5.140 Blue Power - low roof - High visibility**  
UH6223

**ABOUT THIS MODEL**

- 1/ Foldable outside mirrors
- 2/ Detailed interior with new armrest, screen and gears
- 3/ Front and rear standard UH realistic coupling system
- 4/ All wordings are made in tampoprinting
- 5/ Complete new low roof with high visibility sunroof



  
 115 pcs    108 times    366 g    16.0 x 9.8 x 71 cm

Complete  
new model





ABOUT THIS MODEL

- 1/ Adjustable third point linkage
- 2/ New standard realistic UH coupling system

Complete new model



NEW HOLLAND T5.140 Blue Power - 2019

UH6207

115 pcs  
 109 times  
 387 g  
 16.0 x 9.6 x 7.1 cm

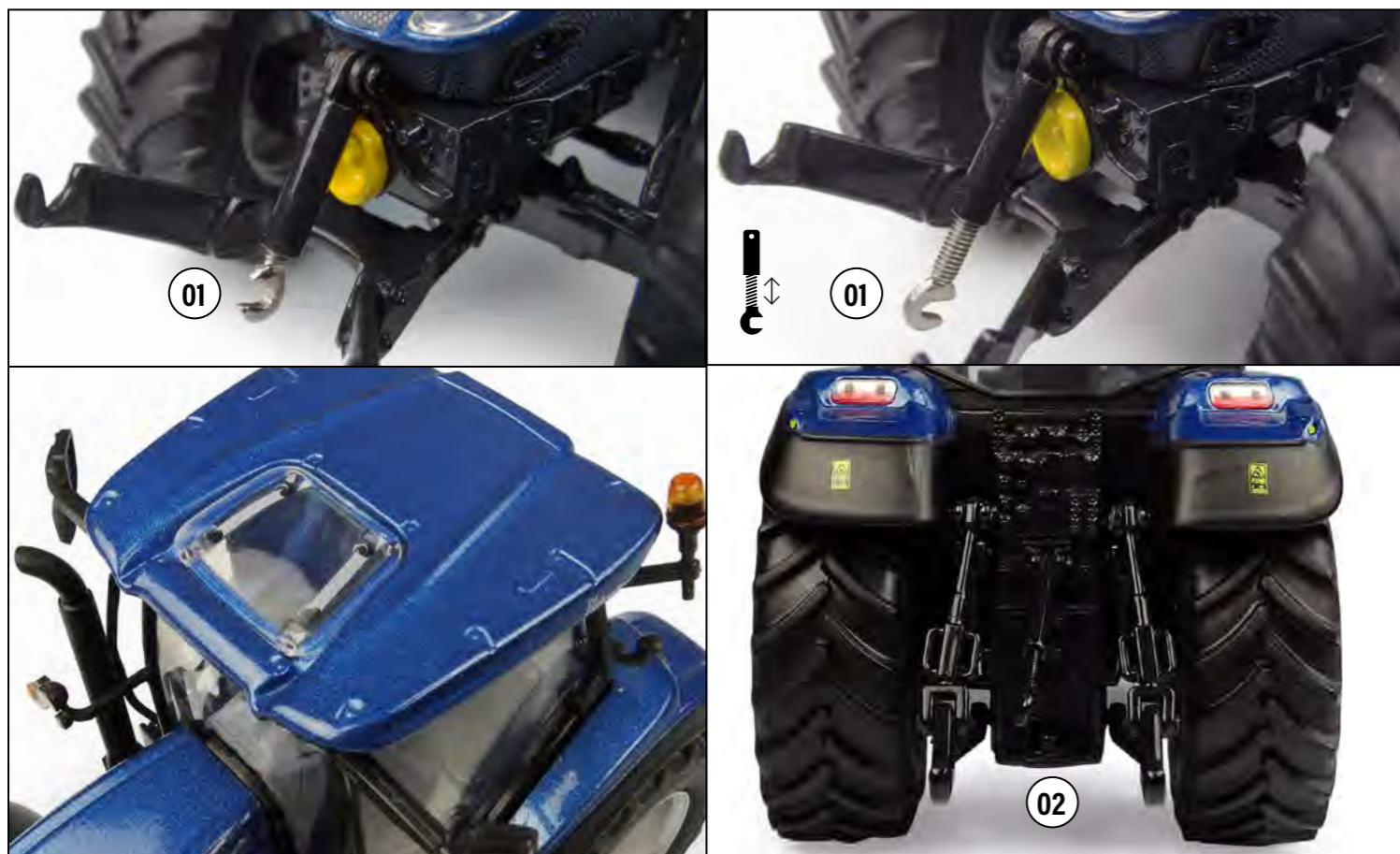

01

02

03

03

BACK IN STOCK



NEW HOLLAND T6.165

UH5263

121 pcs  
 115 times  
 391 g  
 16.5 x 9.6 x 7.8 cm

ABOUT THIS MODEL

- 1/ New foldable outside mirrors
- 2/ New command armrest
- 3/ New front hood printing

NEW HOLLAND T6.175 Blue Power with 770TL front loader

UH5320



158 pcs  
 146 times  
 460 g  
 19.9 x 9.7 x 8.4 cm





ONE OFF!

REAL TRACTOR ON DISPLAY IN NEW HOLLAND BASILDON FACTORY - UK

new



NEW HOLLAND T6.180 - "Heritage blue Edition"  
Celebrating 100 years of tractors from first Ford Model F to New Holland T7 Series  
UH6234

ABOUT THIS MODEL  
1/ White Ford color  
2/ Blue Ford body color  
3/ Side graphics fully tampoprinted

121 pcs 120 times 391 g 16.5 x 9.6 x 7.8 cm



NEW HOLLAND T7.165 S  
UH5265

131 pcs 140 times 416 g 16.8 x 10.0 x 7.8 cm

BACK IN STOCK



NEW HOLLAND T7.225 Blue Power  
UH4976

171 pcs 135 times 480 g 16.8 x 11.8 x 7.8 cm

BACK IN STOCK





BACK IN STOCK



NEW HOLLAND T7.225 Blue Power with tracks UH5365

179 pcs 173 times 432 g 17.0 x 10.3 x 9.9 cm



REAL MODEL



UH6253





New

LIMITED EDITION  
600 PIECES

NEW HOLLAND T5.140 - Profondo Blue  
50th Anniversary New Holland HFT Japan Inc.  
UH6254

118 pcs 120 times 387 g 16.0 x 9.6 x 7.1 cm



New

LIMITED EDITION  
600 PIECES

NEW HOLLAND T6.175 - Profondo Blue  
50th Anniversary New Holland HFT Japan Inc.  
UH6252

110 pcs 120 times 391 g 16.5 x 9.6 x 7.8 cm



New

LIMITED EDITION  
600 PIECES

NEW HOLLAND T5.140 - Gold edition  
50th Anniversary New Holland HFT Japan Inc.  
UH6255

118 pcs 131 times 387 g 16.0 x 9.6 x 7.1 cm



New

LIMITED EDITION  
600 PIECES

NEW HOLLAND T6.175 - Gold edition  
50th Anniversary New Holland HFT Japan Inc.  
UH6253

110 pcs 110 times 391 g 16.5 x 9.6 x 7.8 cm



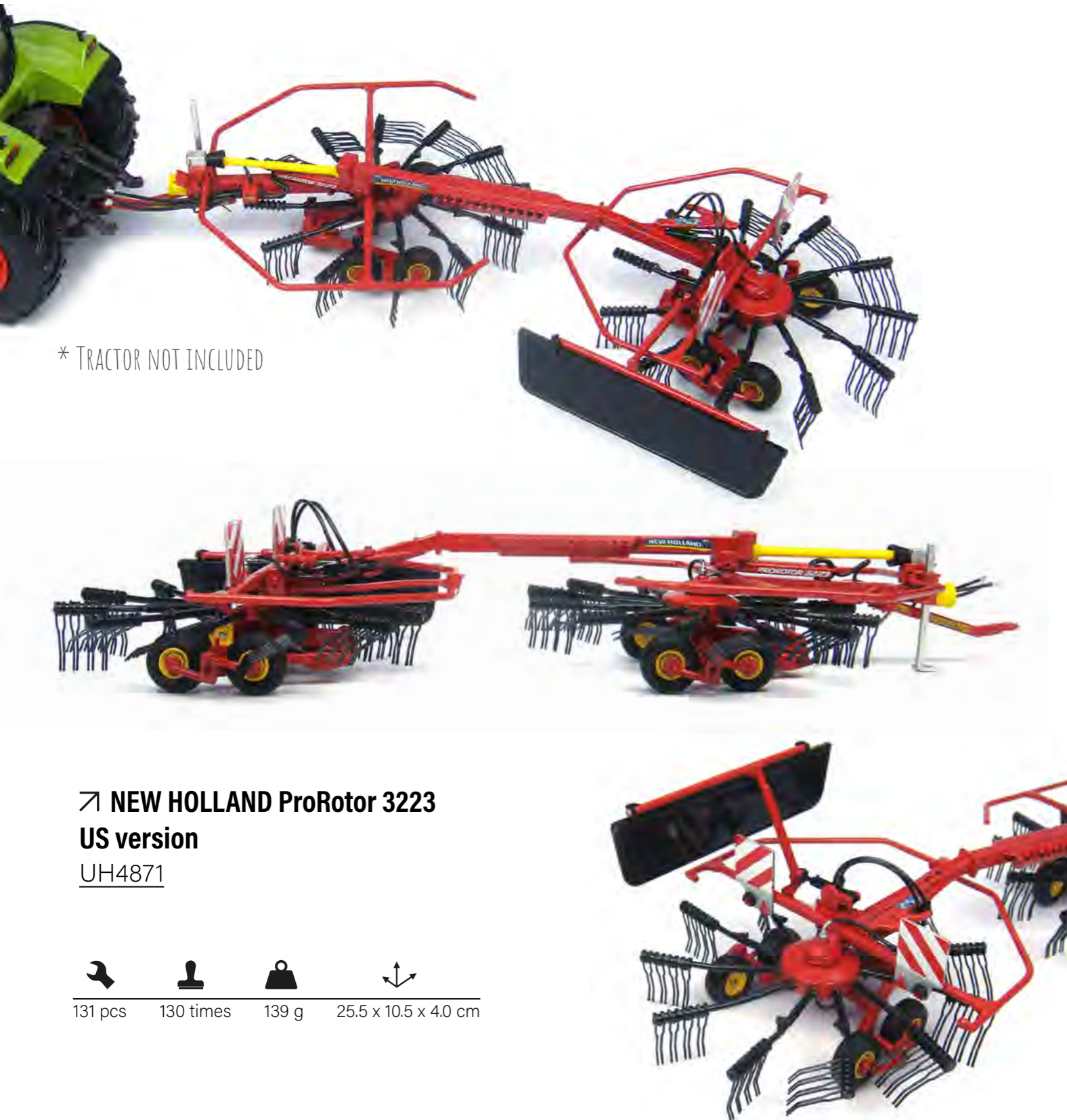

\* TRACTOR NOT INCLUDED

NEW HOLLAND ProRotor 3223  
US version  
UH4871

131 pcs 130 times 139 g 25.5 x 10.5 x 4.0 cm



ABOUT THIS MODEL  
1/ "Twin Rotor" logo tampoprinted  
2/ "Revelation" logo tampoprinted

NEW HOLLAND CR10.90 "Revelation" with tracks  
UH5248



TWIN ROTOR

175 pcs 198 times 1493 g 42.0 x 41.0 x 15.0 cm



REAL MODEL

**FIAT**

FIAT

[Back to contents](#)

SCALE 1:32



## ↓ FIAT Centenario Concept - 100th Fiat Anniversary Celebration

UH5382

### ABOUT THIS MODEL

*Design inspired by the Mythic Series 90*

- 1/ Special side hood printing that links today's tractor to Fiat original and iconic Series 90
- 2/ Terracotta body color with metallic finish
- 3/ New Holland emblem is in Terracotta heritage color
- 4/ Number «100» is engraved on the floor
- 5/ Anniversary years are engraved on rear fenders



76 pcs  
 100 times  
 297 g  
 15.0 x 7.1 x 7.0 cm







**BACK IN STOCK**



105 pcs 93 times 196 g 13.0 x 7.0 x 8.1 cm

**FIAT 750 SPECIAL DT - 4WD with "Fritzmeier" cabin**  
UH5296

**ABOUT THIS MODEL**  
1/ Fritzmeier cabin  
2/ Soft material cover  
3/ 4WD front axle



**BACK IN STOCK**



**FIAT 750 SPECIAL DT - 2WD with canopy**  
UH5255

91 pcs 82 times 196 g 12.4 x 6.9 x 8.0 cm



**ABOUT THIS MODEL**  
1/ Complete new low roof with high visibility sunroof  
2/ Foldable outside mirrors  
3/ Front and rear adjustable third point linkage  
4/ Detailed interior with new armrest, screen and gears



**STEYR Expert 4130 CVT - low roof - High visibility**  
UH6221

**New** Complete new model



111 pcs 118 times 368 g 16.0 x 9.8 x 7.1 cm





\* TRACTOR NOT INCLUDED

### STRAUTMANN Magnon 470 DO

UH6202

117 pcs  
 114 times  
 1380 g  
 33.0 x 12.5 x 8.0 cm

**ABOUT THIS MODEL**

- 1/ Adjustable pick-up height with turning wheels
- 2/ Opening side door panel
- 3/ Tandem swing wheels
- 4/ Sloping perforated front wall
- 5/ Large rear door clearance
- 6/ Assembly with 3 working drums with ripping tins



**new**

### STRAUTMANN Magnon 470 DO

UH6202

**ABOUT THIS MODEL**

- 7/ Removable ladder
- 8/ Rear directional wheels
- 9/ Rear metal chain on moving floor
- 10/ Detailed cutting unit



**new**

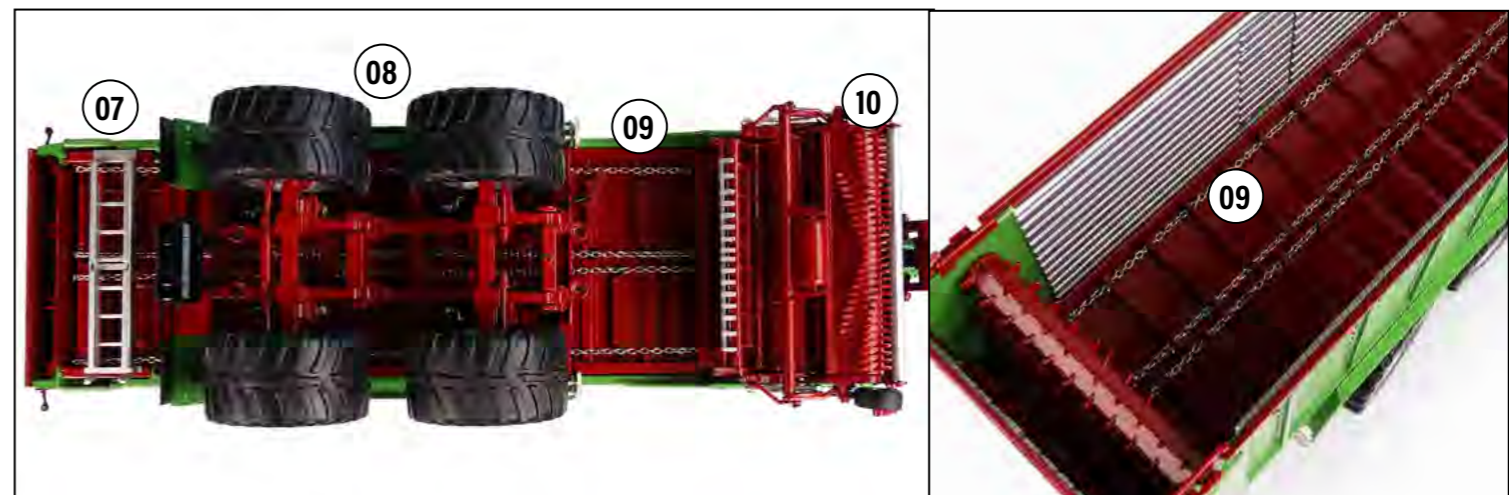





TAARUP  
SCALE 1:32

Back to contents



SCALE 1:32

30 pcs 50 times 48 g 10.5 x 8.5 x 10.0 cm

Back to contents

TAARUP DM 1350 - 1974  
UH4965

ABOUT THIS MODEL  
1/ Rotating part  
2/ Movable part

BACK IN STOCK



\* TRACTOR NOT INCLUDED



TAARUP Tipvogn T3  
UH4964

36 pcs 42 times 60 g 12.5 x 9.0 x 5.5 cm





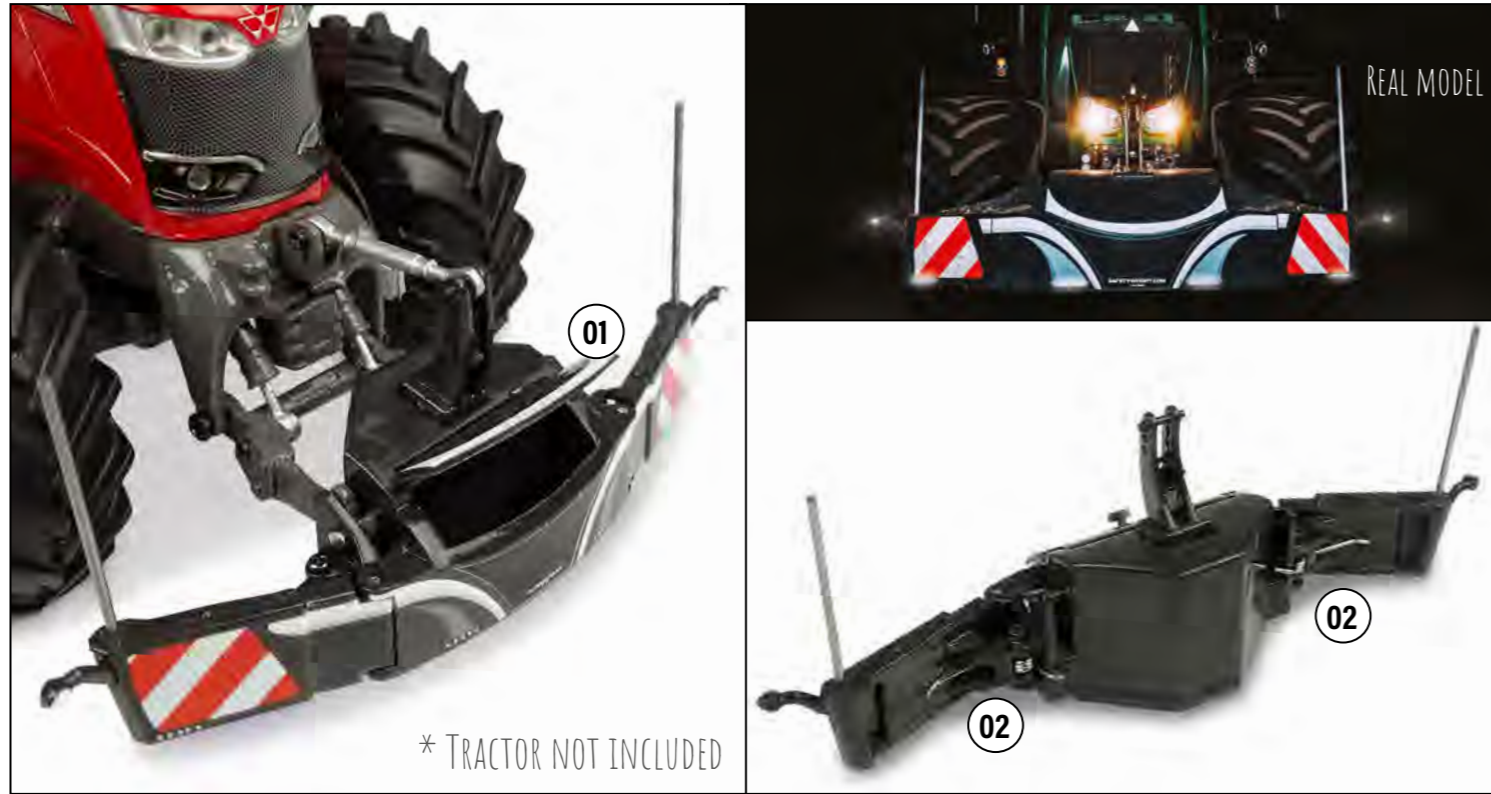

\* TRACTOR NOT INCLUDED

02

02

03

03

04

05

**TRACTORBUMPER Safetyweight 800 kg - grey**  
UH5348

13 pcs 13 times 90 g 9.0 x 7.8 x 3.5 cm

**BACK IN STOCK**

COLOR FRAME: GREY - RAL 7021  
USED FOR : FENDT / MASSEY FERGUSON / VALTRA

ABOUT UH5348 / UH5372 / UH6251 / UH6250  
1/ Integrated toolbox with opening cover  
2/ Adjustable/Movable bumper-ends  
3/ Metallic bumper guide  
4/ Reflective red-white panels  
5/ LED Lighting tampoprinted

**TRACTORBUMPER Safetyweight 800 kg - black**  
UH5372

13 pcs 13 times 90 g 9.0 x 7.8 x 3.5 cm

COLOR FRAME: BLACK - RAL 9011  
USED FOR : NEW HOLLAND / CASE IH / DEUTZ-FAHR



**TRACTORBUMPER Safetyweight 800 kg - blue**  
UH6251

13 pcs 13 times 90 g 9.0 x 7.8 x 3.5 cm

COLOR FRAME: BLUE  
USED FOR : NEW HOLLAND / LANDINI



**TRACTORBUMPER Safetyweight 800 kg - red**  
UH6250

13 pcs 13 times 90 g 9.0 x 7.8 x 3.5 cm

COLOR FRAME: RED  
USED FOR : MASSEY FERGUSON / MC CORMICK







URSUS

SCALE 1:32

Back to contents



→ **URSUS 1204 - 4WD**  
UH5283

76 pcs   82 times   303 g   14.6 x 8.6 x 6.9 cm



VALTRA

SCALE 1:32

Back to contents



# VALTRA UNLIMITED G 135



UH6294 →



→ **URSUS 1201 - 2WD**  
UH5284

74 pcs   80 times   265 g   14.6 x 8.6 x 6.9 cm





**VALTRA G 135 - 2021 - Metallic black**  
UH6291

129 pcs 150 times 365 g 15.0 x 9.6 x 6.9 cm



**VALTRA G 135 - 2021 UNLIMITED EDITION - Burnt orange**  
UH6292

99 pcs 120 times 391 g 16.5 x 9.6 x 7.8 cm



**VALTRA G 135 - 2021 - Red**  
UH6293

129 pcs 150 times 365 g 15.0 x 9.6 x 6.9 cm



**VALTRA G 135 - 2021 UNLIMITED EDITION - Turquoise**  
UH6294

99 pcs 120 times 391 g 16.5 x 9.6 x 7.8 cm





VICON

SCALE 1:32

[Back to contents](#)



**BACK IN STOCK**

### VICON Pendulum Spreader - Serie B 75

UH5330 \* TRACTOR NOT INCLUDED

16 pcs 18 times 14 g 4.2 x 4.1 x 3.3 cm

#### ABOUT THIS MODEL

- 1/ Retractable side plate
- 2/ Functional hydraulic cylinder
- 3/ Functional parking stand crutch



VOLMER

SCALE 1:32



WORK POSITION

TRANSPORT POSITION



ALL METAL MODEL

### VOLMER VTS 300 - Silage telescopic shield

UH6225 \* TRACTOR NOT INCLUDED

21 pcs 22 times 111 g 15.0 x 5.0 x 3.3 cm



WEEKS

SCALE 1:32

[Back to contents](#)



### WEEKS «Popular» - 3.5 Ton Hydraulic tipping trailer

UH6215



\* TRACTOR NOT INCLUDED

#### ABOUT THIS MODEL

- 1/ «WEEKS» logo tampoprinted on new side panels
- 2/ Complete new brake, part stand and lever
- 3/ New screw-jack stand
- 4/ Working hydraulic cylinder
- 5/ Metal chassis
- 6/ New metal frame
- 7/ Movable rear door

**new**

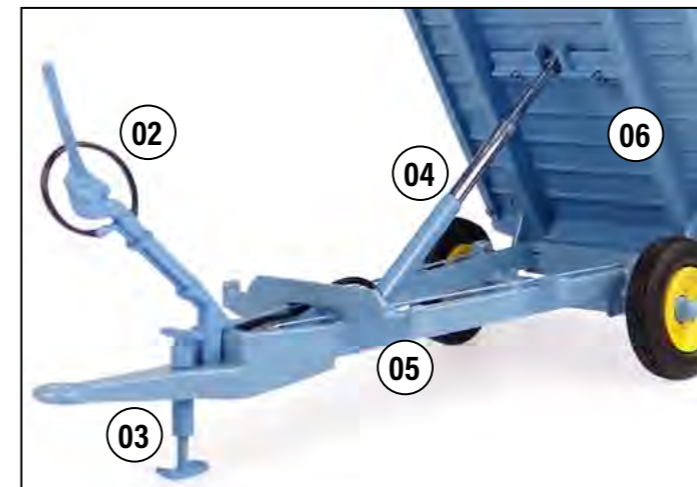





20 pcs 35 times 126 g 12.9 x 6.0 x 5.7 cm





➤ WEEKS «Hi-Side» - 3.5 Ton Hydraulic tipping trailer  
UH6229

\* TRACTOR NOT INCLUDED



  
 21 pcs    33 times    132 g    12.9 x 6.0 x 5.7 cm

**ABOUT THIS MODEL**

- 1/ Quick release rear door
- 2/ Extension side panels
- 3/ Complete new brake, part stand and lever
- 4/ New screw-jack stand
- 5/ New metal frame
- 6/ Working hydraulic cylinder
- 7/ Metal chassis

**New**



\* TRACTOR NOT INCLUDED





**New**

**ABOUT THIS MODEL**

- 1/ Front loading area
- 2/ Rear folding door
- 3/ Silage extension side panels
- 4/ Rear grilles are in photo etching



➤ WEEKS «Convert» with silage extension sides  
3.5 Ton Hydraulic tipping trailer  
UH6230

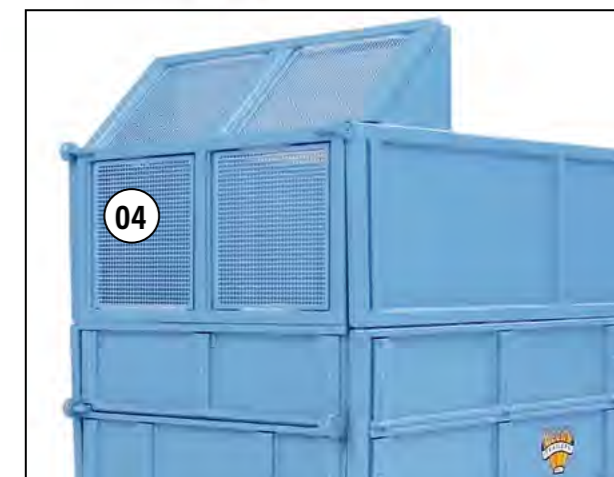

  
 24 pcs    37 times    145 g    12.9 x 6.0 x 9.7 cm





# YANMAR

YANMAR

SCALE 1:32

[Back to contents](#)



→ **YANMAR YTE113**  
UH4889



134 pcs   125 times   362 g   15.0 x 8.5 x 6.5 cm

# Zetor

ZETOR

SCALE 1:32

[Back to contents](#)

SCALE 1:32

[Back to contents](#)

### ABOUT THIS MODEL

- 1/ New 4-cylinder engine
- 2/ Short wheelbase

→ **ZETOR Crystal 8011 - 2WD**  
UH5246



69 pcs   103 times   270 g   13.1 x 8.6 x 6.9 cm



↑ **ZETOR Crystal 160**  
UH4951

87 pcs   135 times   438 g   16.8 x 8.1 x 9.5 cm





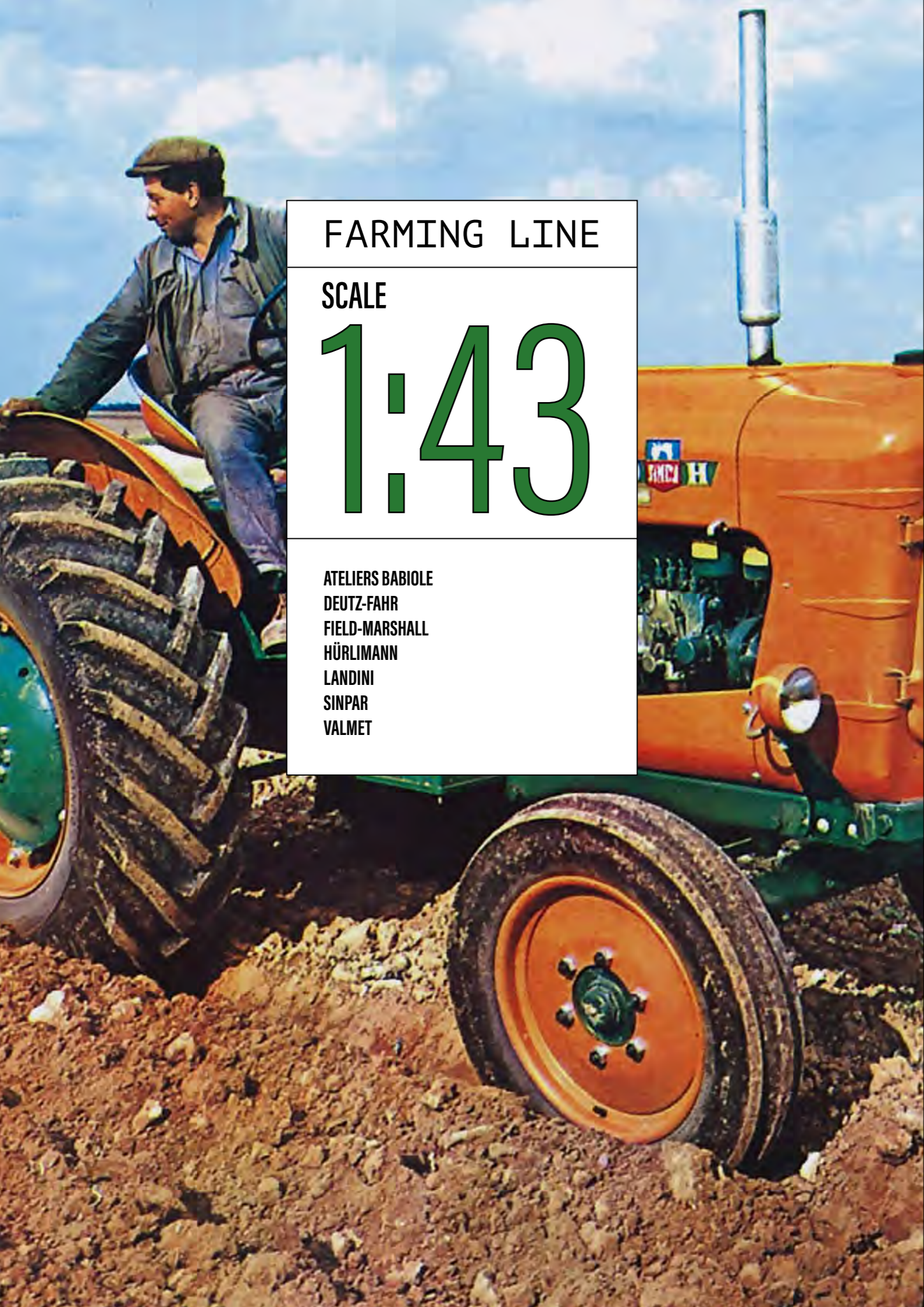

FARMING LINE

SCALE  
**1:43**

- ATELIERS BABIOLE
- DEUTZ-FAHR
- FIELD-MARSHALL
- HÜRLIMANN
- LANDINI
- SINPAR
- VALMET

SCALE 1:43



61 x 3.3 x 4.3 cm

➤ **BABIOLE Super Babi 203 - 1954**  
UH6024



7.5 x 4.5 x 4.4 cm

➤ **DEUTZ F2M315 - 1938**  
UH6105



7.5 x 4.5 x 5.0 cm

➤ **FIELD-MARSHALL Serie 3 - 1949**  
UH6063



6.6 x 4.0 x 3.5 cm

➤ **HÜRLIMANN H12 - 1951**  
UH6052



6.0 x 3.1 x 3.2 cm

➤ **LANDINI C25 - 1957**  
UH6060



8.5 x 4.5 x 5.3 cm

➤ **SINPAR Castor 1200 D - 1965**  
UH6055



7.4 x 4.4 x 5.0 cm

➤ **VALMET 565 - 1966**  
UH6034



7.2 x 4.1 x 4.2 cm

➤ **VALMET 33 Diesel - 1957**  
UH6097





FARMING LINE

SCALE

**1:87**

CASE IH







CASE IH

SCALE 1:87



↗ CASE IH International Axial Flow 1660  
UH6103



 93 pcs    27 times    118 g    9.9 x 6.3 x 4.8 cm



# FARMING LINE Keychains

- CASE IH
- CHALLENGER
- CLAAS
- DEUTZ-FAHR
- FENDT
- FORDSON
- JOSKIN
- KUHN
- MASSEY FERGUSON - FERGUSON
- Mc CORMICK
- STEYR
- VALTRA



➤ CASE IH 1455XL 3rd Generation  
UH5841



➤ CASE IH 1455XL 4th Generation  
UH5842



➤ CASE IH 1455XL "Black Beauty"  
UH5843



➤ CASE IH Axial Flow 9240  
UH5834

BACK IN STOCK



➤ CASE IH Magnum 380 CVX  
UH5821



➤ CASE IH Magnum 380 CVX - 2020  
UH5861



➤ CASE IH Magnum 315 CVT - 150 000 Edition  
UH5823



➤ CASE IH Puma 240 CVX  
UH5817







KEYRINGS

[Back to contents](#)



➤ **CASE IH Autonomous Concept Vehicle**  
[UH5830](#)



➤ **CHALLENGER 1050**  
[UH5839](#)

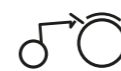

KEYRINGS

[Back to contents](#)



➤ **DEUTZ-FAHR Agrottron TTV 9340 "Warrior"**  
[UH5849](#)



➤ **DEUTZ-FAHR Vari Master 660**  
[UH5838](#)



➤ **CLAAS Axion 960 Terra Trac**  
[UH5858](#)

**new**



➤ **CLAAS Jaguar 960 Terra Trac**  
[UH5855](#)

**new**



**BACK IN STOCK**

➤ **FENDT 828 Vario "Nature Green" color**  
[UH5845](#)



➤ **FENDT 939 Vario "Nature Green" color**  
[UH5831](#)



➤ **CLAAS Torion 1914**  
[UH5860](#)

**new**



➤ **CLAAS Xerion 5000 Trac TS**  
[UH5859](#)

**new**



➤ **FENDT 1050 Vario**  
[UH5844](#)

**BACK IN STOCK**



➤ **FENDT Ideal 9T - 2020**  
[UH5865](#)

**new**



➤ **CLAAS Lexion 8900 Terra Trac**  
[UH5856](#)

**new**



➤ **DEUTZ-FAHR Agrottron TTV 9340**  
[UH5835](#)



➤ **FORDSON Power Major**  
[UH5569](#)

**BACK IN STOCK**



➤ **JOSKIN Modulo II 11000 ME**  
[UH5846](#)



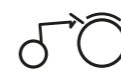

↑ **KUHN VB 2295**  
UH5833



↗ **FERGUSON TEA 20**  
UH5565

**BACK IN STOCK** ↖



↗ **Mc CORMICK X8.680 - Red**  
UH5829



↗ **NEW HOLLAND T7.225**  
UH5812



↗ **MASSEY FERGUSON 135**  
UH5566



↗ **MASSEY FERGUSON 7726**  
UH5828

**BACK IN STOCK** ↖



↗ **NEW HOLLAND T7.225 "Blue Power"**  
UH5814

**BACK IN STOCK** ↖



↗ **NEW HOLLAND T8.350 - 2020**  
UH5862



↗ **MASSEY FERGUSON 8737**  
UH5827



↗ **MASSEY FERGUSON 8S.265 - 2021**  
UH5864

**new**



↗ **STEYR 9105 MT**  
UH5576



↗ **VALTRA T4 Series - red**  
UH5818



**new**

↗ **MASSEY FERGUSON Ideal 9T - 2020**  
UH5866



↗ **Mc CORMICK X8.680 - "Yellow" Edition**  
UH5850





 [Back to contents](#)

# CONSTRUCTION EQUIPMENT LINE



SCALE  
**1:12**

SCALE  
**1:50**

**Keyrings**









CONSTRUCTION  
EQUIPMENT  
LINE

SCALE  
**1:12**

WACKER NEUSON







→ **WACKER NEUSON Rammer BS60**  
UH8076

14 pcs    47 times    98 g    7.5 x 5.0 x 2.5 cm







↗ **WACKER NEUSON Hammer EH25**  
with accessories  
UH8075

15 pcs    25 times    81 g    8.2 x 4.5 x 2.0 cm

↗ **WACKER NEUSON Hammer EH65**  
with accessories  
UH8082

15 pcs    25 times    81 g    8.2 x 4.5 x 2.0 cm





CONSTRUCTION  
EQUIPMENT  
LINE

SCALE  
**1:50**

Click to access  
the brand directly ↘

CASE CE	141
KOMATSU	142



↖ **CASE 580 ST**  
UH8079

127 pcs   154 times   128 g   18.3 x 5.8 x 5.0 cm







Complete new model

↑ **KOMATSU WA475-10**  
UH8146

94 pcs 148 times 258 g 18.2 x 7.4 x 6.0 cm

New



HANDLING BUCKET AND FORK INCLUDED  
STONE NOT INCLUDED



↑ **KOMATSU WA600-8 Stone Handler**  
UH8153

New



**ABOUT THIS MODEL**

- 1/ New bucket
- 2/ New fork
- 3/ Additional counterweight bumper compared to standard version





136 pcs 140 times 540 g 24.2 x 10.0 x 7.5 cm





↑ KOMATSU WA600-8  
UH8127

**BACK IN STOCK**

 134 pcs  
  128 times  
  450 g  
  24.2 x 10.0 x 7.5 cm



→ KOMATSU HD605  
UH8009



**BACK IN STOCK**

 127 pcs  
  32 times  
  528 g  
  20.0 x 11.5 x 10.0 cm



↑ KOMATSU D155AX-7  
UH8010

**BACK IN STOCK**

 213 pcs  
  248 times  
  330 g  
  16.0 x 8.0 x 6.6 cm







↓ KOMATSU WB93R-8  
UH8142







**ABOUT THIS MODEL**

- 1/ New 2 wheel drive axle
- 2/ New hood
- 3/ New graphics
- 4/ New tank and stairs
- 5/ New front and rear wheels

 129 pcs
  159 times
  131 g
  18.5 x 6.5 x 4.5 cm



↓ KOMATSU WB97S-8  
UH8139

 136 pcs
  167 times
  129 g
  18.5 x 6.5 x 4.5 cm



**ABOUT THIS MODEL**

- 1/ New tank and stairs
- 2/ New graphics
- 3/ New front hood design







→ **KOMATSU WA100M-8**  
UH8145

**BACK IN STOCK**



70 pcs   84 times   130 g   12.0 x 6.0 x 4.5 cm



↗ **KOMATSU PW148-10 with standard & ditch cleaning bucket**  
UH8083

INCLUDES 2 ACCESSORIES

146 pcs   154 times   209 g   20.5 x 8.2 x 6.9 cm



↗ **KOMATSU PW148-10 with clamshell**  
UH8100

129 pcs   163 times   192 g   20.5 x 8.2 x 6.9 cm



185 pcs 142 times 222 g 23.0 x 7.5 x 6.0 cm

KOMATSU HB205-3 Hybrid  
UH8136



BACK IN STOCK

ABOUT UH8136 & UH8122  
1/ New engine cover  
2/ Complete new body side graphic decoration  
3/ New cameras



BACK IN STOCK

KOMATSU PC210LC-11 with hammer drill  
UH8140

182 pcs 145 times 220 g 22.0 x 7.5 x 6.0 cm

181 pcs 126 times 222 g 23.0 x 7.5 x 6.0 cm

KOMATSU PC210LC-11  
UH8122



BACK IN STOCK



ABOUT THIS MODEL  
1/ New engine cover  
2/ New decoration  
3/ New cameras  
4/ New front body panel

BACK IN STOCK

187 pcs 134 times 223 g 23.0 x 7.5 x 6.0 cm

KOMATSU PC210LCi-11 Intelligent machine control  
UH8123



04







→ **KOMATSU HB215LC-3 Hybrid**  
UH8135

**ABOUT THIS MODEL**

- 1/ New engine cover
- 2/ Complete new body side graphic decoration

 185 pcs  
  142 times  
  222 g  
  23.0 x 7.5 x 6.0 cm





**BACK IN STOCK**







↓ **KOMATSU PC490LC-11**  
UH8120



**BACK IN STOCK**

 214 pcs  
  199 times  
  503 g  
  28.0 x 7.1 x 7.0 cm

 262 pcs  
  224 times  
  511 g  
  28.0 x 7.1 x 7.0 cm

↓ **KOMATSU PC490LC-10**  
UH8090





CONSTRUCTION  
EQUIPMENT  
LINE

# Keyrings

KOMATSU



↗ **KOMATSU HD605**  
UH5540

**BACK IN STOCK** ↶



↗ **KOMATSU WA470**  
UH5526

**BACK IN STOCK** ↶



↗ **KOMATSU WH613**  
UH5525



↗ **KOMATSU WH613 - Chrome finish**  
UH5554



↗ **KOMATSU HB215LC Hybrid**  
UH5852



↗ **KOMATSU HB205LC Hybrid**  
UH5853

→ **KOMATSU PC210LC-11**  
UH5854

**BACK IN STOCK** ↶







# STUFFED toys 3+

Click to access the brand directly ▾

Farming	
CASE IH	157
CLAAS	157
MASSEY FERGUSON	158
Mc CORMICK	159
NEW HOLLAND	160
Construction equipment	
CASE CE	162
KOMATSU	163



↗ CASE IH Axial Flow

UHK1128

↕  
34.0 x 23.5 x 20.0 cm



UHK1147



100% polyester

ALL OUR PRODUCTS ARE UNDER LICENSE AND COMPLY WITH EU & US HARMONISED STANDARDS



↗ CLAAS Lexion - 2019 version

UHK1144

↕  
35.0 x 23.0 x 18.5 cm





→ CLAAS Jaguar

UHK1140



35.0 x 26.5 x 19.5 cm

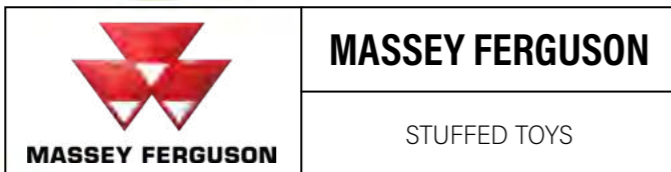

→ MASSEY FERGUSON 8S.265

UHK1147



27.0 x 25.0 x 20.0 cm



→ MASSEY FERGUSON 8000 Series

UHK1123



31.0 x 26.0 x 22.0 cm



→ Mc Cormick X8

UHK1122



31.0 x 27.0 x 25.0 cm





**NEW HOLLAND**

STUFFED TOYS

[Back to contents](#)



**NEW HOLLAND T7**

UHK1103

270 x 240 x 220 cm



**NEW HOLLAND - combine**

UHK1120

360 x 250 x 200 cm

STUFFED TOYS

[Back to contents](#)



**NEW HOLLAND T7 - mini format**

UHK1113

140 x 120 x 100 cm



**NEW HOLLAND Basildon mascot**

UHK1138

220 x 260 x 60 cm







↗ CASE CE - bulldozer

UHK1116



29.5 x 20.5 x 20.0 cm



↗ CASE CE - skid loader

UHK1117



32.0 x 19.5 x 20.3 cm



↗ KOMASTU WB93R

UHK1148



43.0 x 24.0 x 26.0 cm



↗ KOMATSU HD605

UHK1131



29.0 x 27.5 x 20.0 cm



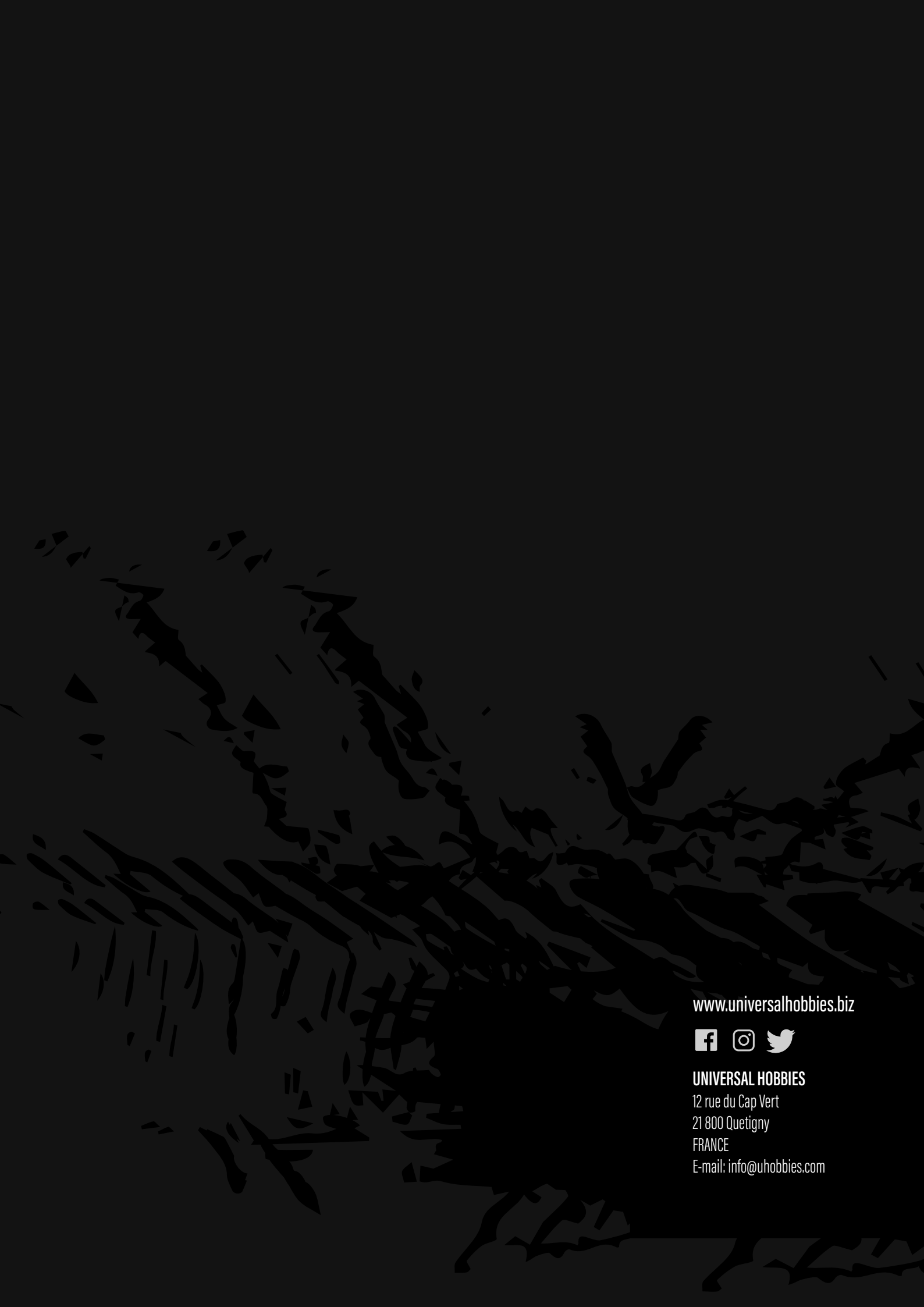

[www.universalhobbies.biz](http://www.universalhobbies.biz)

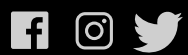

**UNIVERSAL HOBBIES**

12 rue du Cap Vert

21 800 Quetigny

FRANCE

E-mail: [info@uhobbies.com](mailto:info@uhobbies.com)